

# ROBERTS

Sound for Generations



## CD9913

Stereo CD Radio  
Cassette Recorder

Please read this manual before use

<i>Important Information</i> .....	1
<i>Controls</i> .....	2-5
<i>Battery Operation</i> .....	6
<i>Mains Operation</i> .....	6
<i>Listening to the radio - FM</i> .....	7
<i>Listening to the radio - Medium and Long wave</i> .....	8
<i>Compact discs</i> .....	9
<i>Inserting a CD</i> .....	9
<i>Playing a CD</i> .....	10
<i>Selecting a track</i> .....	10
<i>Search function</i> .....	10
<i>Playback modes</i> .....	11
<i>Programmed play</i> .....	12
<i>Checking a programme</i> .....	12
<i>Erasing a programme</i> .....	12
<i>Adding tracks to a programme</i> .....	13
<i>Replacing previously programmed tracks</i> .....	13
<i>Playing a programme</i> .....	13
<i>Listening to cassette tapes</i> .....	14
<i>Recording from the radio</i> .....	15
<i>Recording from CD</i> .....	16
<i>Preventing accidental erasure</i> .....	17
<i>Cleaning tape heads</i> .....	17

<i>Specification</i> .....	18
<i>Guarantee</i> .....	Back cover



### **Warning**

**CLASS 1 LASER PRODUCT** means that the laser's construction makes it inherently safe so that the legally prescribed maximum permissible radiation values can never be exceeded

**Caution:** Using any equipment or devices other than those described and specified in these operating instructions, or tampering with the unit in any way, can result in dangerous exposure to radiation.

## Controls

(Front)

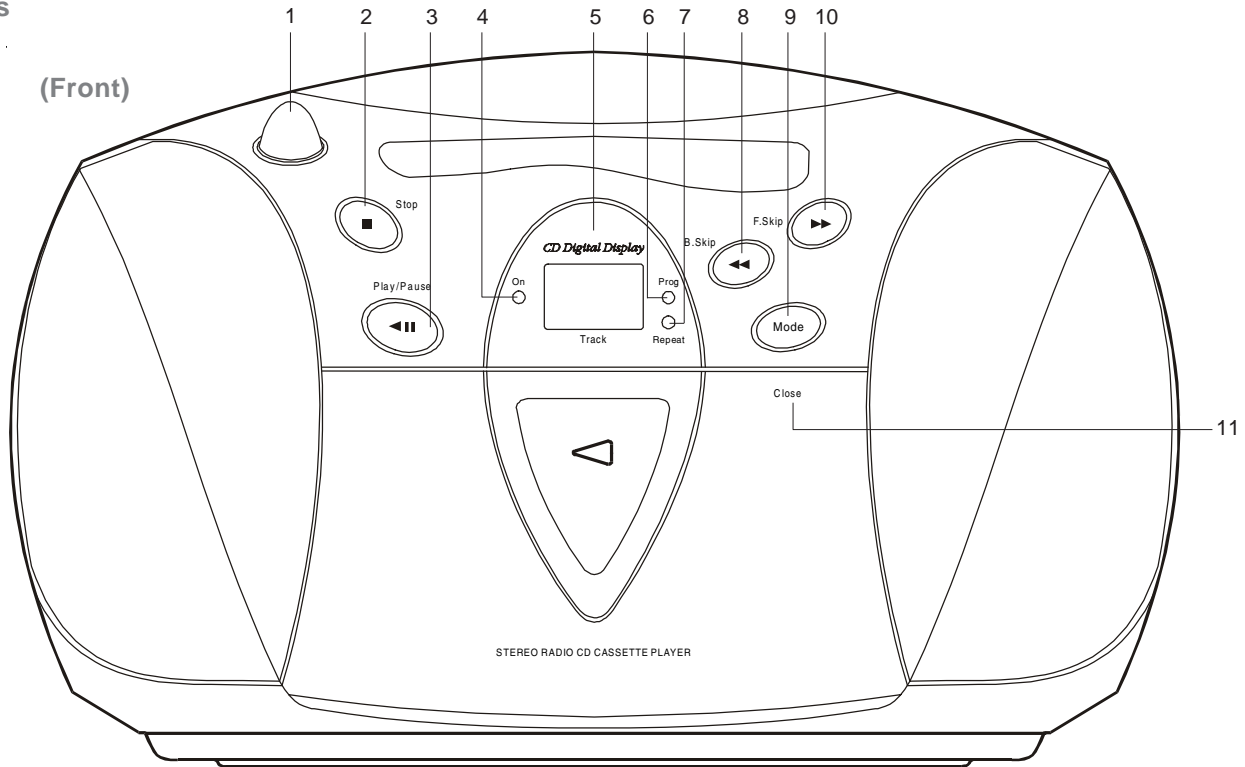

1. Volume control
2. CD Stop button
3. CD Play/Pause button
4. Power indicator

5. CD display
6. Programme indicator
7. Repeat indicator
8. Backward skip button

9. Mode button
10. Forward skip button
11. Cassette door

If you need any further advice, please call our Technical Helpline on :-  
020 8758 0338 (Mon-Fri)

# Controls

(Top)

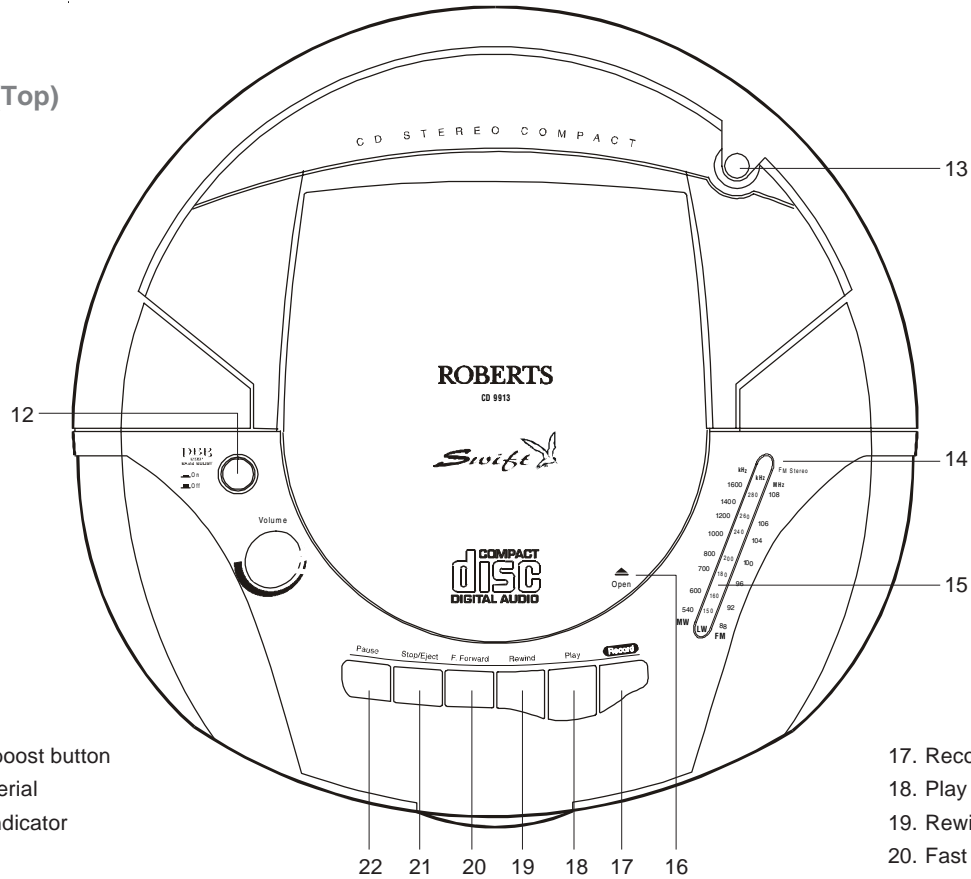

- 12. Deep bass boost button
- 13. Telescopic aerial
- 14. FM stereo indicator
- 15. Tuning dial
- 16. CD lid

- 17. Record button
- 18. Play button
- 19. Rewind button
- 20. Fast forward button
- 21. Stop/Eject button
- 22. Pause button

**Controls**

**(Right side)**

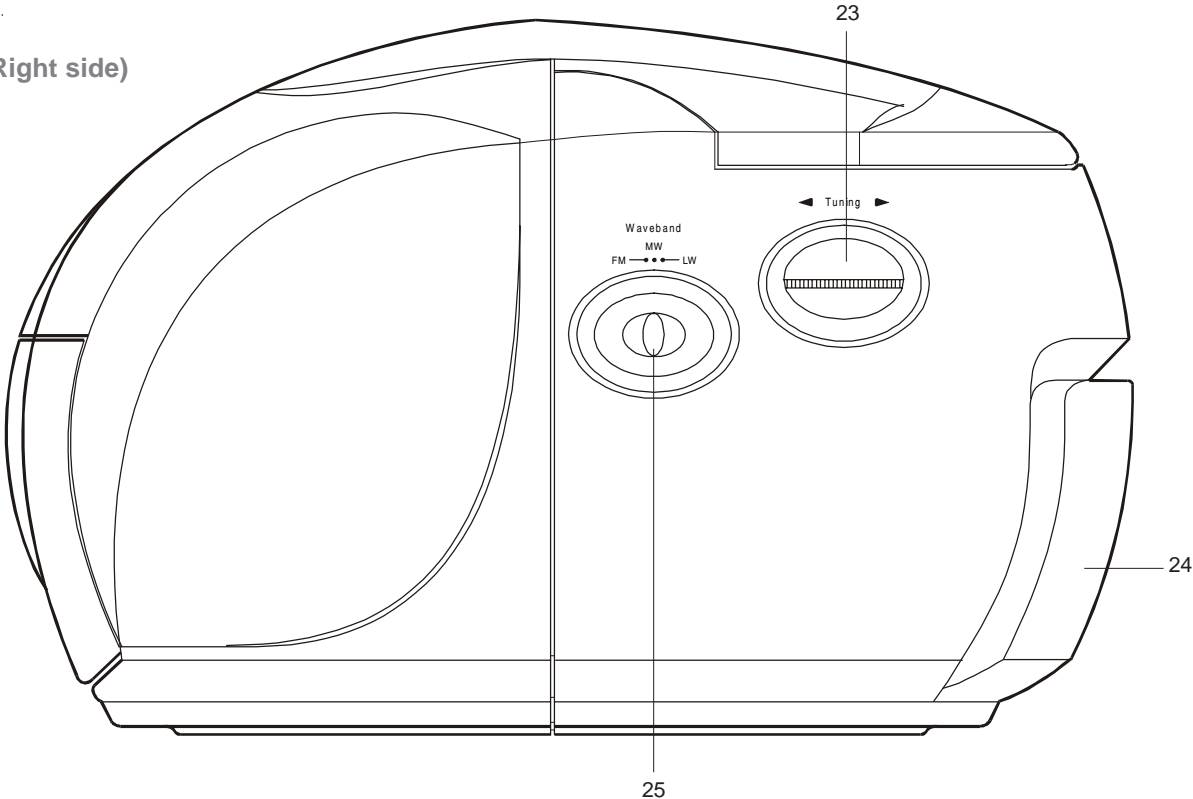

- 23. Tuning control
- 24. Battery compartment (on rear)
- 25. Waveband selector

*If you need any further advice, please call our Technical Helpline on :-  
020 8758 0338 (Mon-Fri)*

# Controls

(Left side)

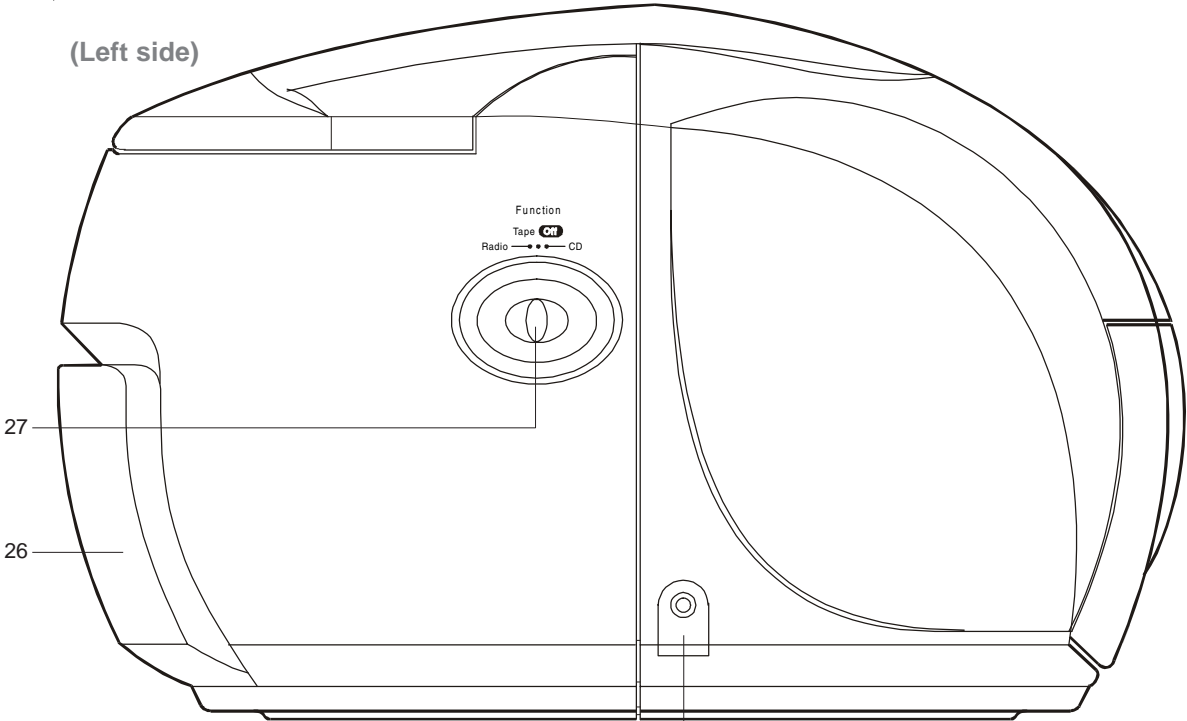

27

26

28

- 26. Mains socket (on rear)
- 27. Function switch
- 28. Headphone socket

## Battery operation

1. Remove the **Battery cover** on the rear of your CD radio cassette by pushing the catches in the direction of the arrows.
2. Insert eight LR14 (C size) batteries into the spaces in the compartment. Take care to ensure all batteries are inserted with the correct polarity as shown inside the battery compartment. Replace the battery cover.
3. Reduced power, distortion, and a 'stuttering' sound are all signs that the batteries may need replacing. If your CD radio cassette is not to be used for any extended period of time it is recommended that the eight LR14 (C size) batteries are removed from the radio.

*We would recommend for economy that the CD9913 is used on the mains whenever possible with battery operation for occasional or stand-by use only.*

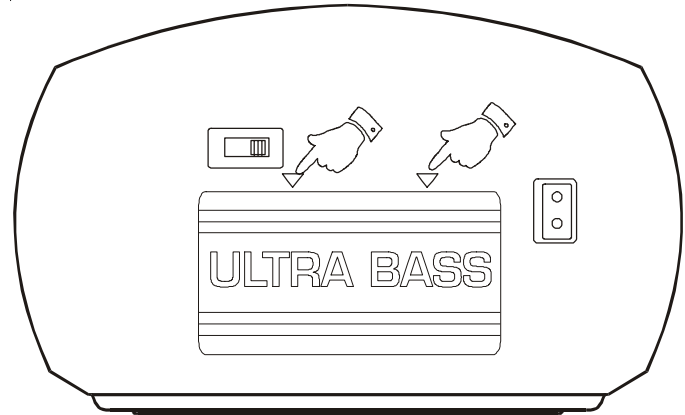

## Mains operation

1. Place your CD radio cassette on a flat surface.
2. Plug the mains lead into the socket located on the rear of your CD radio cassette ensuring that the plug is pushed fully into the socket.
3. Plug the other end into a mains wall socket and switch on.

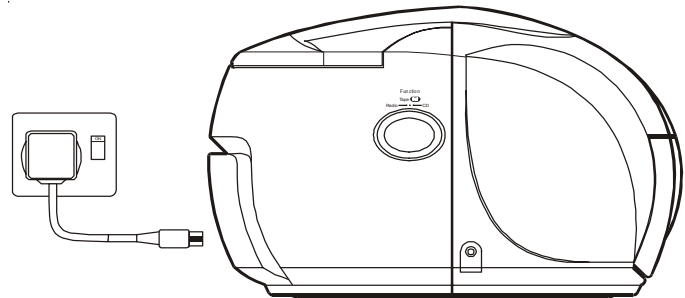

*If you need any further advice, please call our Technical Helpline on :-  
020 8758 0338 (Mon-Fri)*

## Listening to the radio - FM

1. Set the **Function switch** to the 'Radio' position. The **Power indicator** will light up.
2. Select 'FM' using the **Waveband switch**.
3. Adjust the **Volume control** until a hissing sound is heard.
4. The **Telescopic aerial** which is only operational on FM, should be fully extended.
5. Carefully tune to the desired station using the **Tuning control**.
6. Angle and rotate the **Telescopic aerial** to a position giving the best reception. A knuckle joint at the base of the aerial allows this movement and an angle of 45 degrees will usually be satisfactory. The FM band is marked in Megahertz (MHz).
7. To receive stereo broadcasts set the **FM mode switch** located on the rear of your CD radio cassette to the 'Stereo' position the **Stereo indicator** will light up. If the station being received is weak some hiss may be audible, to reduce the hiss set the **FM mode switch** to the 'Mono' position to return to mono operation.
8. Adjust the **Deep bass boost** switch to the required position.
9. To switch off the radio set the **Function switch** to the 'Tape Off' position.

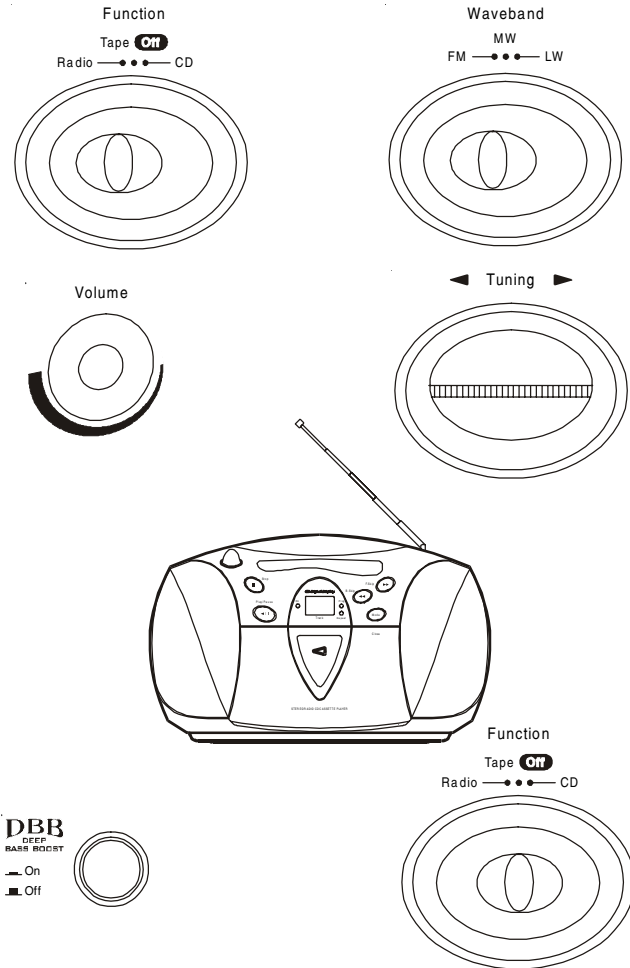



## Listening to the radio - Medium and Long wave

1. Set the **Function switch** to the 'Radio' position.
2. Select 'MW' or 'LW' using the **Waveband switch**.
3. Adjust the **Volume control** until a hissing sound is heard.
4. Carefully tune to the desired station using the **Tuning control**.
5. Rotate your CD radio cassette for optimum reception.
6. The MW and LW bands are marked in kilohertz (kHz).
7. Adjust the **Deep bass boost** switch to the required position.
8. To switch off the radio set the **Function switch** to the 'Tape Off' position.

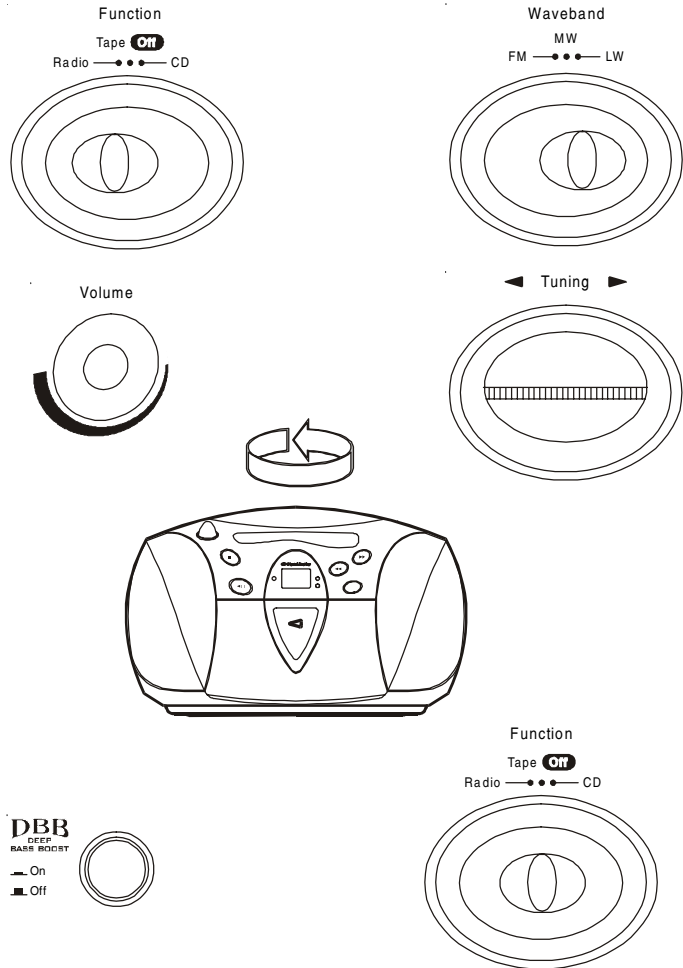

If you need any further advice, please call our Technical Helpline on :-  
020 8758 0338 (Mon-Fri)

## Compact discs

Use only Digital Audio CDs which have the



symbol.

Never write on a CD or attach any sticker to the CD. Always hold the CD at the edge and store it in its box after use with the label facing up.

To remove dust and dirt, breathe on the CD and wipe it with a soft, lint-free cloth in a straight line from the centre towards the edge.

Cleaning agents may damage the CD

Do not expose the CD to rain, moisture, sand, or to excessive heat. (e.g. from heating equipment or in motor cars parked in the sun).

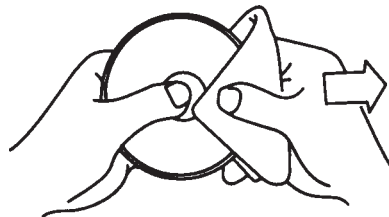

## Inserting a CD

1. Set the **Function switch** to CD. The **Power indicator** will light up.
2. If you select CD and have not inserted a CD, 'no' appears on the display.
3. To open the CD compartment, push the **CD door** on the edge marked Open
4. Insert an Audio CD, printed side facing up. Close the door. The CD player will scan the contents of the CD and the total number of tracks will appear on the display.

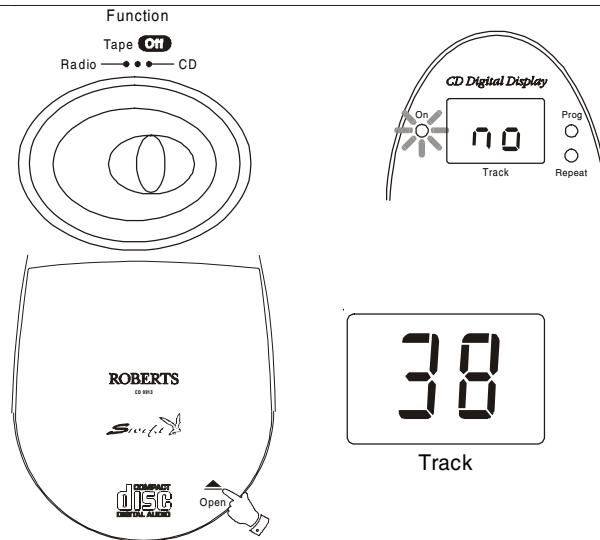

## Playing a CD

1. Press the **Play/Pause button** to start playback. The **Play/Pause button** will light up and the display shows the track number.
2. Set the **Volume** and **Deep bass boost controls** to the required settings.
3. To pause playback press the **Play/Pause button**. The **Play/Pause button** will flash. To resume playback press the **Play/Pause button** again.
4. To stop playback, press the **Stop button**. The total number of CD tracks will then appear on the display.
5. To take out the CD, open the CD door by pushing the edge marked Open. The CD door should only be opened when the CD is in Stop mode.

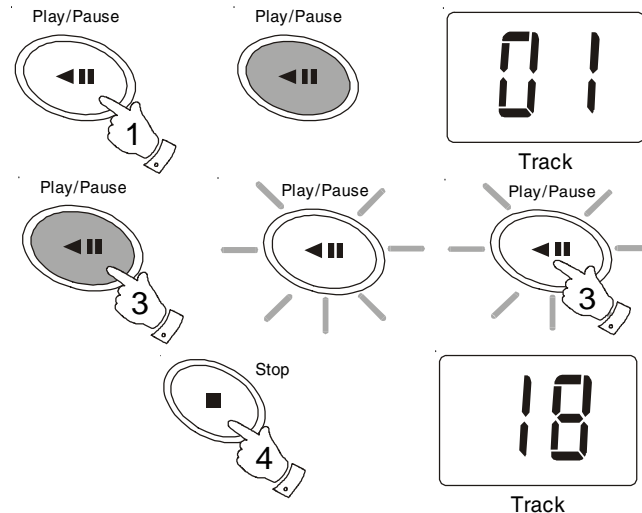

## Selecting a track

1. Whilst the CD is playing, press either the **F.skip** or **B.skip buttons** to change to the desired track. You can also skip tracks when the player is in stop mode. Skip to the desired track using the **F.skip** or **B.skip buttons**.
2. Press the **Play/Pause button** to play the selected track.

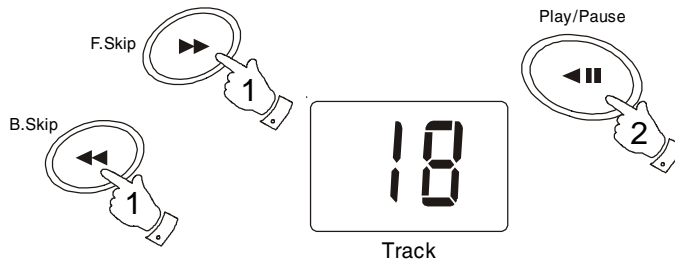

## Search function

1. Whilst the CD is playing, press and hold down either the **F.skip** or **B.skip buttons**. Release the button when the desired part of the track is reached.

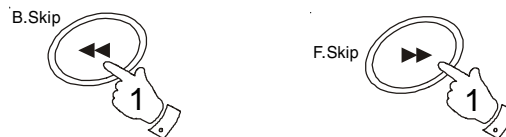

## Playback modes

The **Mode button** allows you to select different CD playback modes in the following order:-

REPEAT1 → REPEAT ALL → RANDOM → NORMAL

These modes can only be selected or changed during CD playback.

1. Whilst the CD is playing press the **Mode button** once to repeat the current track. The **Repeat indicator** will light up.
2. Press the **Mode button** again to repeat all tracks on the CD. The **Repeat indicator** will flash.
3. Press the **Mode button** again to play all tracks on the CD in random order. The display indication toggles between the track number and a moving symbol. The tracks are played in random order until all tracks have been played.
4. Press the **Mode button** again to return to normal play. The display will return to showing current track number.  
Random mode is not possible during playback of a CD programme.
5. Pressing the **Stop button** will stop the CD and return the CD player to normal play mode.

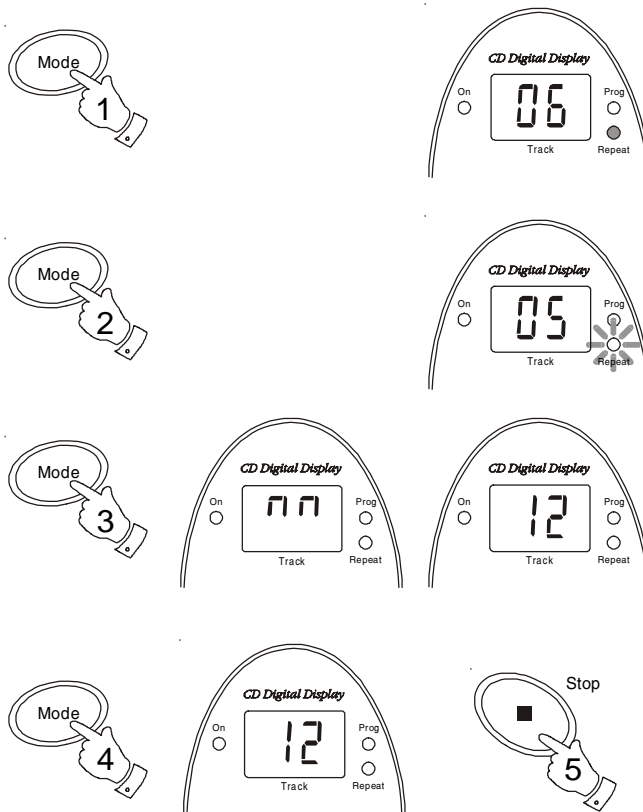

## Programmed play

By programming the player you can play up to 21 tracks in any desired order.

1. Whilst the CD is in STOP mode, press the **Mode button**. The **Programme indicator** will start to flash and the display will show '01'.
2. Select the first track using the **F.skip** or **B.skip** buttons. The track number flashes on the display and the **Programme indicator** lights up. Store this track by pressing the **Mode button**.
3. The **Programme indicator** will flash and the display will show '02'.
4. Repeat the above steps until you have completed your program. Press the **Play/Pause** button to commence play of the selected tracks.

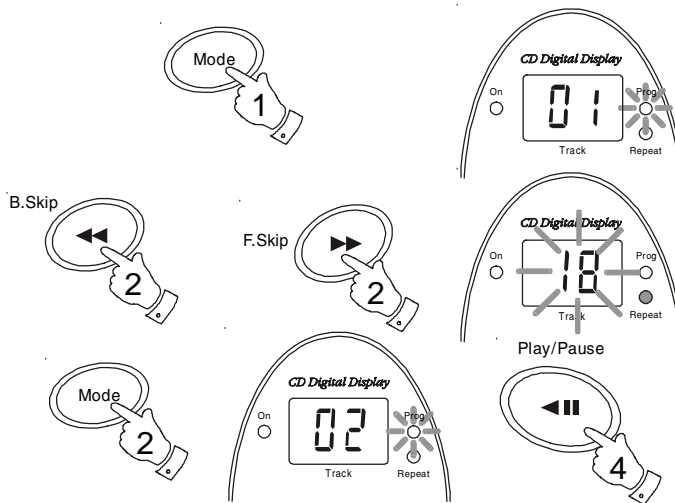

## Checking a programme

1. Whilst the CD is in STOP mode, press the **Mode button**. The **Programme indicator** will flash.
2. Press the **Play/Pause** button to start playback of the programme.
3. Repeatedly press and release the **F.skip** button to step through the programme. The display will show the programmed track numbers and playback of the respective track will start.

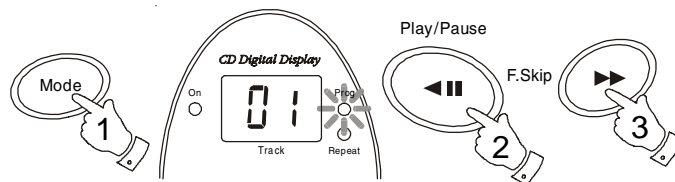

## Erasing a programme

1. Whilst the CD is in STOP mode, press the **Mode button**. The **Programme indicator** will flash.
2. Press the **Stop button** to cancel the programme. Programmes are also erased by:- Opening the **CD door**, moving the **Function switch** to the 'Tape/Off' or 'Radio' positions and if the power supply is interrupted in any way.

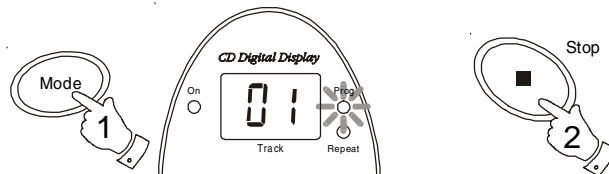

If you need any further advice, please call our Technical Helpline on :-  
020 8758 0338 (Mon-Fri)

## Adding tracks to a programme

1. Whilst the CD is in STOP mode, press the **Mode button** repeatedly until the display shows the first empty memory location (the largest number)
2. You can now add tracks (up to 21) to the sequence as described earlier.

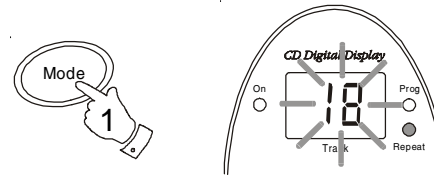

## Replacing previously programmed tracks

1. Whilst the CD is in STOP mode, press the **Mode button** repeatedly until the display shows the programme step you wish to replace.
2. Select the track you want to enter in its place using the **F.skip** or **B.skip buttons**.
3. Press the **Mode button** to store the track.
4. Press the **Play/Pause** button to start playback of the programme.

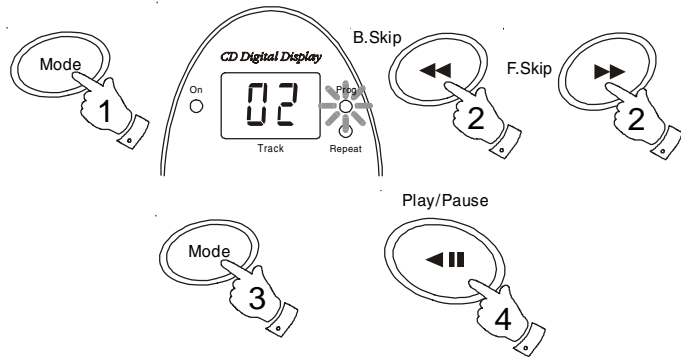

## Playing a programme

1. Whilst the CD is in STOP mode, press the **Mode button**, the **Programme indicator** will flash.
2. Press the **Play/Pause** button, play will commence with the first track of the programme and finish with the last track of the programme.
3. Whilst playing a programme it is possible to change to the next or previous track in the programme using the **F.skip** or **B.skip buttons**.

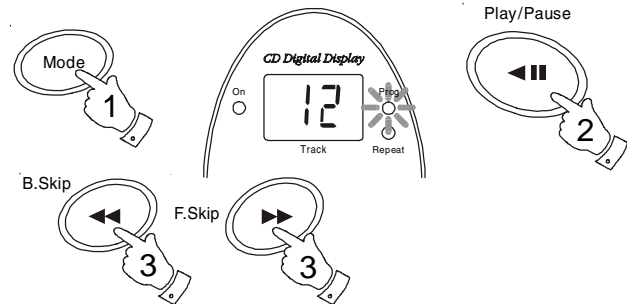

## Listening to cassette tapes

1. Set the **Function switch** to the 'Tape' position.
2. Press the **Stop eject button** to open the **Cassette compartment**.
3. Insert a pre-recorded cassette with the tape surface uppermost and the side with the desired recording facing towards you.
4. Close the **Cassette compartment**.
5. Depress the **Play button** and adjust the **Volume control** to suit your personal taste.
6. Adjust the **Deep bass boost** switch to the required position.
7. Use the **Fast forward** or **Rewind buttons** to locate a specific part of the tape.
8. If you wish to temporarily stop the playback depress the **Pause button**. When you are ready to resume playback press the **Pause button** a second time.
9. To stop the tape and switch off your CD radio cassette press the **Stop/Eject** button.

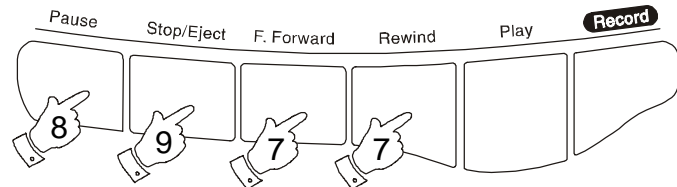
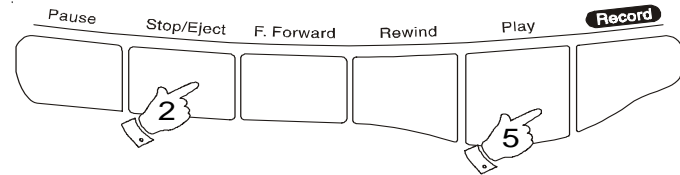
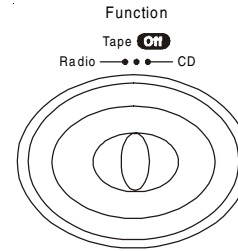

## Recording from the Radio

1. Set the **Function switch** to the 'Radio' position.
2. Tune in to the desired station.
3. Adjust the **Volume control** to suit your requirements.
4. Insert a blank cassette with the tape surface uppermost and the side you wish to record on facing towards you.
5. Depress the **Record button** to commence recording.
6. The recording level is set automatically and is not affected by the setting of the **Volume control**.
7. To stop the recording press the **Stop/Eject button**.

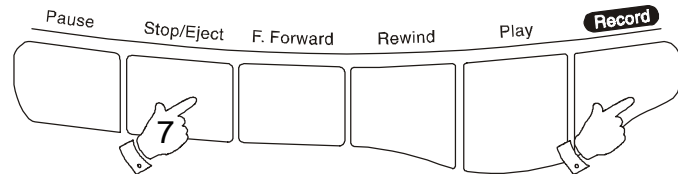
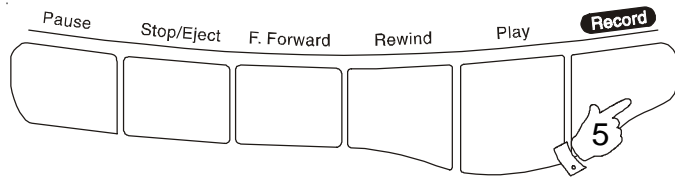
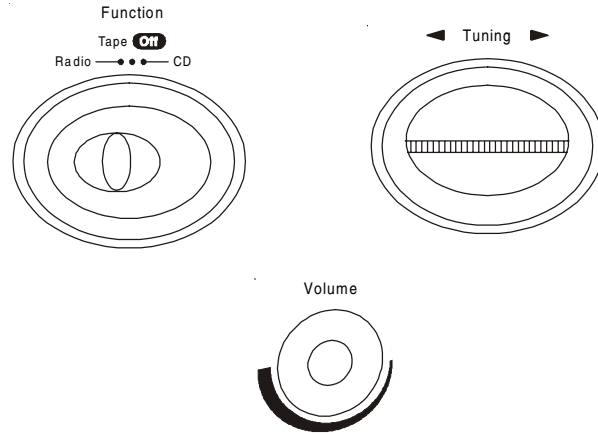



## Recording from CD

1. Set the **Function switch** to the 'CD' position.
2. Insert a CD into the compartment.
4. Insert a blank cassette with the tape surface uppermost.
5. Depress the **Record button** to commence recording. The CD will start automatically (CD syncro start)
6. The recording level is set automatically and is not affected by the setting of the **Volume control**.
7. To stop the recording press the **Stop/Eject button**.

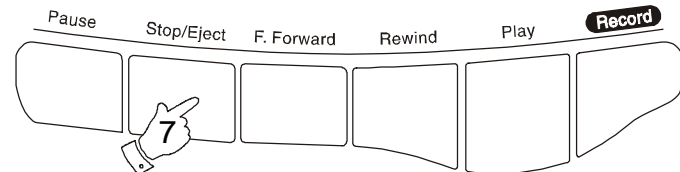
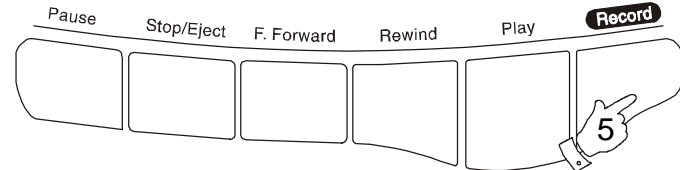
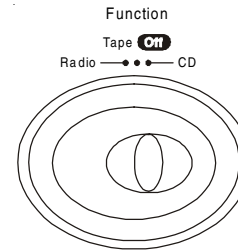

## Preventing accidental erasure

1. To safeguard your recordings against accidental erasure, break off the appropriate tab on the cassette as shown .
2. There is one tab for each side of the cassette. This will prevent the Record button from being pressed.
3. To restore the cassette to normal, seal the tab openings with a small piece of self-adhesive tape.

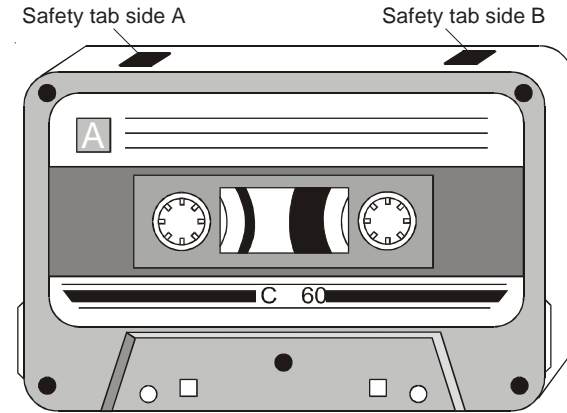

## Cleaning tape heads

The binder and oxide from magnetic tapes can accumulate on the pinch roller (A) the capstan shaft (B) and also the heads (C and D). This will impair the sound quality.

To clean these parts proceed as follows:-

1. Turn off the power to the unit.
2. Press the **Stop/Eject button**.
3. Press the **Play button** and the heads will be clearly seen.
4. Clean the surfaces (A, B, C, D) with a lint free rag or cotton swab soaked in alcohol. Press the stop/eject button as soon as cleaning is over.

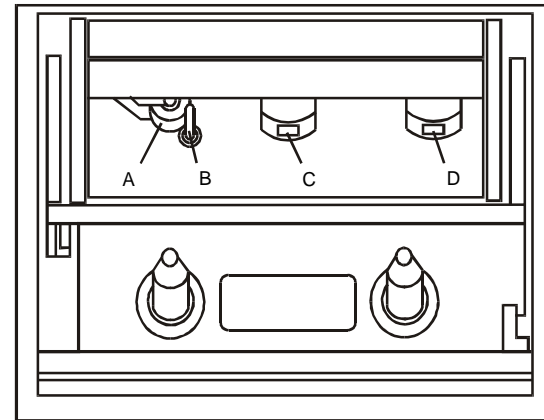

## Specifications

### Power Requirements

Mains	AC 230 volts, 50Hz  only
Batteries	8 x LR14 (C size)

### Frequency Coverage

FM	87.5-108MHz
MW	522- 1620kHz
LW	144- 281kHz

## Circuit Features

Loudspeaker	2 x 77mm 8ohms
Output Power	2 x 1.6 Watts into 4ohms
Headphone socket	3.5mm dia
Aerial System	FM Telescopic aerial
	MW Built-in Ferrite aerial
	LW Built-in Ferrite aerial

### ROBERTSRADIO LIMITED

PO BOX 130  
MEXBOROUGH  
SOUTH YORKSHIRE  
S64 8YT

*The Company reserves the right to amend the specification without notice.*

## Guarantee

This instrument is guaranteed for twelve months from the date of delivery to the original owner against failure due to faulty workmanship or component breakdown, subject to the procedure stated below. Should any component or part fail during this guarantee period it will be repaired or replaced free of charge.

The guarantee does not cover:

1. Damage resulting from incorrect use.
2. Consequential damage.
3. Receivers with removed or defaced serial numbers.

N.B. Damaged or broken telescopic aerials will not be replaced under guarantee.

Procedure:

Any claim under this guarantee should be made through the dealer from whom the instrument was purchased. It is likely that your Roberts' dealer will be able to attend to any defect quickly and efficiently, but should it be necessary the dealer will return the instrument to the company's service department for attention. In the event that it is not possible to return the instrument to the Roberts' dealer from whom it was purchased, please contact Roberts Radio Technical Services department at the address shown below before taking further action.

*These statements do not affect the statutory rights of a consumer.*

### **ROBERTS RADIO TECHNICAL SERVICES DEPARTMENT**

97-99 Worton Road  
Isleworth Middlesex  
TW7 6EG

Technical Helpline:- 020 8758 0338 (Mon-Fri)

Issue 1

